

Description	Specification
External dimensions (height x width)	252 mm x 50 mm
Distance between axis	200 mm
Lenghtways tubes	Extruded alluminium EN AW 6005 T6 - Ø50x1.5mm
Crossways tubes	Extruded alluminium EN AW 6060 T6 - Ø14x1.5mm
Connecting plate	Cast alluminium EN AC 42200 T6
Welding process	TIG -141 / ISO 4063
Available lenght (cm)	12.5 - 25 - 50 - 100 - 150 - 200 - 250 - 300 - 350 - 400
Connection systems	FXFC - FXSM10

Section Area	Moment of inertia Y - axis	Moment of inertia Z - axis	Selfweight (approx.)		
[mm <sup>2</sup> ]	[mm <sup>4</sup> ]	[mm <sup>4</sup> ]	[N/m]		
457	4.020.032	114.376	20		

Span [m]	Centre Point Load (C.P.L.)			Third Point Load (T.P.L.)			Quarter Point Load (Q.P.L.)			Fifth Point Load (F.P.L.)			Uniformly Distributed Load (U.D.L.)		
	Point Load	Full Load	Central Deflection	Point Load	Full Load	Central Deflection	Point Load	Full Load	Central Deflection	Point Load	Full Load	Central Deflection	Load	Full Load	Central Deflection
	[kg]	[kg]	[mm]	[kg]	[kg]	[mm]	[kg]	[kg]	[mm]	[kg]	[kg]	[mm]	[kg/m]	[kg]	[mm]
1	269	269	0,17	135	269	0,15	90	269	0,14	67	269	0,13	269	269	0,11
2	261	261	1,33	134	267	1,16	89	267	1,08	67	267	1,03	134	267	0,86
3	79	79	1,41	51	102	1,54	36	109	1,53	28	113	1,52	45	136	1,51
4	31	31	1,43	20	39	1,54	14	42	1,54	11	43	1,52	13	52	1,51
5	13	13	1,49	8	16	1,53	6	17	1,55	4	18	1,52	4	21	1,51
6	5	5	1,59	2	5	1,52	2	6	1,58	1	5	1,51	1	6	1,51

Load table has been prepared in accordance with UNI ENV 1999-1-1 (Eurocode 9).  
 When calculating the allowable loads shown in the table, it is assumed that the trusses are simply supported at the end connection and that static loads will be applied to the node points.  
 The application of the load shall be on the centre line of the truss.  
 The values shown in the table are the allowable statics loads that can be applied to the truss. This is the live load or the payload.  
 The self weight of the truss has been taken into account when calculating the values in the table.  
 It should be noted that this are idealised loading condition and the User shall re-analyze the truss for the loading condition which prevail for the application begin considered.

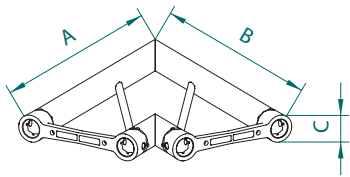

FX25SL2060P

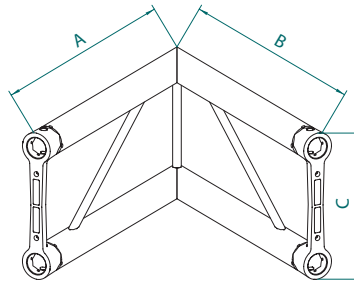

FX25SL2060V

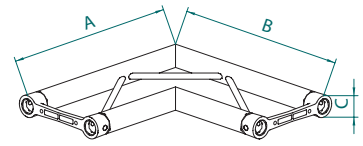

FX25SL2090P

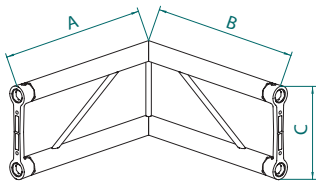

FX25SL2090V

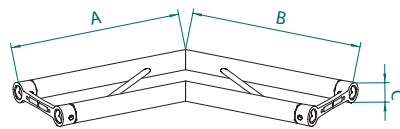

FX25S2120P

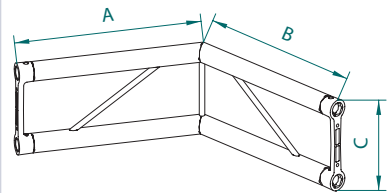

FX25SL2120V

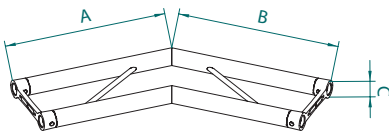

FX25SL2135P

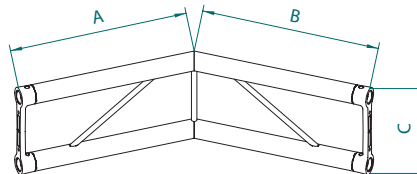

FX25SL2135V

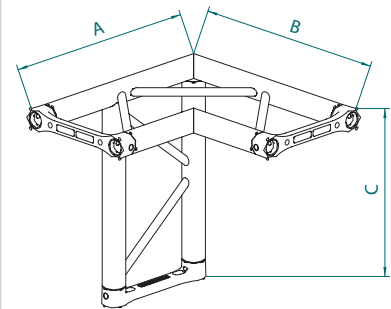

FX25SL3LP

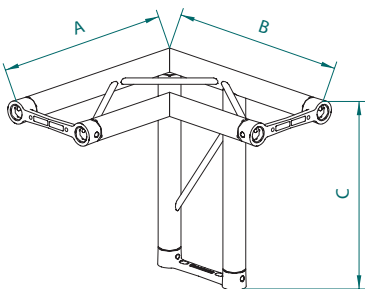

FX25SL3RP

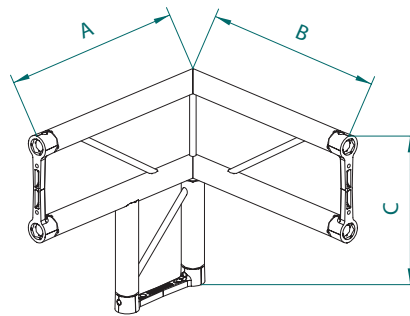

FX25SL3LV

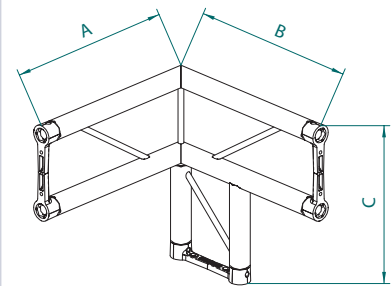

FX25SL3RV

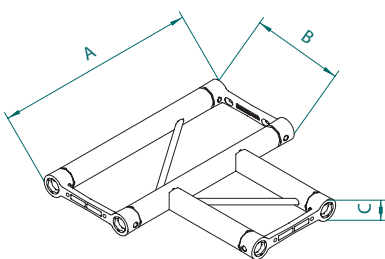

FX25ST3NP

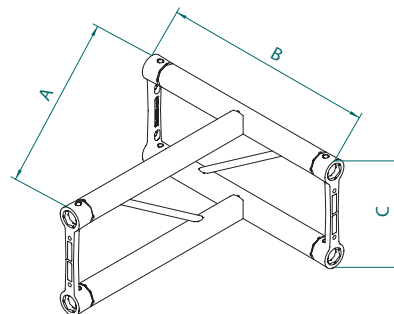

FX25ST3NV

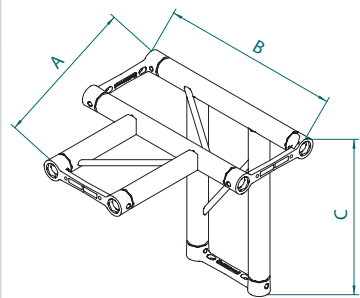

FX25ST4NP

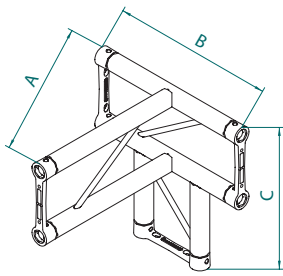

FX25ST4NV

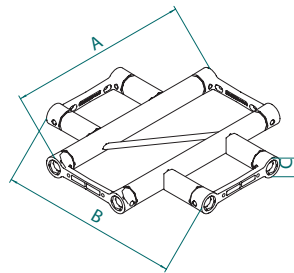

FX25SX4NP

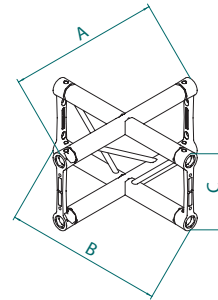

FX25SN4NV

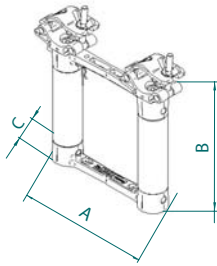

FX25SACL

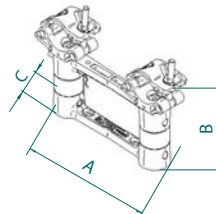

FX25SACS

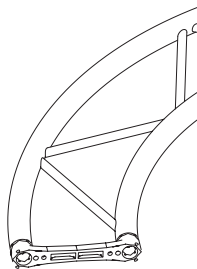

FX25SFP



FX25SFV

### CORNERS

Code	Dimension A x B x C (cm)	Weight(Kg)
FX25SACS	25x12.5x5	1.70
FX25SK2	25x5x5	1.20
FX25SK4	25x25x5	3.30
FX25SL2045P	50x50x5	2.00
FX25SL2045V	50x50x25	3.00
FX25SL2060P	50x50x5	2.70
FX25SL2060V	50x50x25	3.30
FX25SL2090P	50x50x5	1.70
FX25SL2090V	50x50x25	1.80
FX25SL2120P	50x50x5	1.70
FX25SL2120V	50x50x25	1.90
FX25SL2135P	50x50x5	2.10
FX25SL2135V	50x50x25	1.90
FX25SL3LP	50x50x50	2.50
FX25SL3LV	50x50x50	2.70
FX25SL3RP	50x50x50	2.70
FX25SL3RV	50x50x50	2.70
FX25ST3NP	50x50x5	2.10
FX25ST3NV	25x50x50	2.10
FX25ST4NP	50x50x55	3.00
FX25ST4NV	50x50x50	2.70
FX25SX4NP	50x50x5	2.10
FX25SX4NV	50x50x25	2.40
FX25SACL	25x25x5	4.10

### TRUSS

Code	Dimensions (cm)	Wright (Kg)
FX25S012M5	25x5x12.5	0.80
FX25S025	25x5x25	1.00
FX25S050	25x5x50	1.50
FX25S100	25x5x100	2.20
FX25S150	25x5x150	3.00
FX25S200	25x5x200	3.90
FX25S250	25x25x250	4.60
FX25S300	25x5x300	5.40
FX25S350	25x5x350	6.20
FX25S400	25x5x400	7.00

### RINGS

Curves, rings and ellipses are available on demand

Minimum diameter 2 m

Diameter measurement external

Weight per meter (aprox.) 2,5 Kg